

GRAVITY BUTT SPURS WHEEL AND 1-3/8" DIA. X 18 GA. GALV. ROLLER BUTT SPURS



Roach gravity roller butt spurs divert flow of goods at 30° or 45°, right or left and 90° by simply adding a standard 45° curve to spur.

ROLLER BUTT SPURS MODEL NUMBER

BSR-12-1.5-30-R

BSR-(overall width*)-(roller centers**)-(degree@)-(left or right hand#)

*Specify 12", 18" or 24" OAW.

**Specify 1.5" or 3" roller centers. NOTE: 2 week shipment on models with 1.5" roller centers.

@Specify 30° or 45°.

#See page 8 to determine hand of spur.

WHEEL BUTT SPURS MODEL NUMBER

BSW-12-30-R

BSW-(overall width*)-(degree@)-(left or right hand#)

*Specify 12", 18" or 24" OAW.

@Specify 30° or 45°.

#See page 8 to determine hand of spur.

SPECIFICATIONS

ROLLERS: 1-3/8" x 18 ga. galvanized steel roller, model 138G, on model BSR.

WHEELS: 1-15/16" dia. prelubricated ball bearing wheel with hardened raceway, zinc plated on model BSW.

FRAMES: Formed galvanized steel channel 2-1/2" x 1" x 12 ga.; supplied with hook and rod coupling.

■ 24 hour shipment ■ 2 week shipment

1.9" DIA. X 16 GA. STEEL ROLLER BUTT SPURS



Roach gravity roller butt spurs divert flow of goods at 30° or 45°, right or left and 90° by simply adding a standard 45° curve to spur.

1.9" ROLLER BUTT SPURS MODEL NUMBER

RBS-13-30-R

RBS-(between frames)-(degree@)-(left or right hand#)

@Specify 30° or 45°.

#See page 8 to determine hand of spur.

SPECIFICATIONS

ROLLERS: 1.9" x 16 ga. steel, model 196S.

FRAMES: Formed steel channel, 3-1/2" x 1-1/2" x 10 ga.; 13", 15", 17", 19", 21", 23", 25", 27", 31", 33", 37", 39", 43", 47" and 51" BF available.

ROLLER CENTERS: Model RBS furnished with 3" roller centers.

BEARINGS: Integral plain ball bearings, zinc plated, grease packed.



■ 24 hour shipment

PRODUCT STOPS

MEDIUM DUTY PNEUMATIC ROLLER AND BLADE STOPS (FOR GRAVITY)



Pneumatic gravity conveyor stops are used where automatic line control is required such as slug accumulation, indexing, etc.

This stop is designed for 3-1/2" and 4" deep frames.

PNEUMATIC STOPS MODEL NUMBER PRSL-196-21

P (roller or blade stop*)(left or right**)-
(roller type@)-(between frames)

*Specify RS for roller stop; BS for blade stop.

**Specify L for left hand; R for right hand.

@Specify 196 for 196S, 192 for 192S, 199 for 199S.

SPECIFICATIONS

ROLLER STOP: 1.9" dia. x 16 ga. steel 196S roller for medium duty; 2.5" dia. x 11 ga. steel 251S roller for heavy duty.

BLADE STOP: 7 ga. formed angle.

AIR CYLINDER: Double action.

(60-80 PSI required)

BEARINGS: Removable type, heavy duty ball bearing, with cast iron housings.

SOLENOID VALVE: Single.

LOCK: Positive over center locking device to hold position.

WIDTHS: 24 hour shipments include 13", 15", 17", 19", 21", 23", 25", 27", 31", 33", 37", 39", 43", 45", 47" and 51" BF.

OPTIONAL: Double solenoid/elec. controls.

■ 24 hour shipment

MEDIUM DUTY MANUAL ROLLER AND BLADE STOPS (FOR GRAVITY)



Manual operated gravity conveyor stops are hand operated and used where line control is required such as slug accumulation, indexing, workstations, etc.
This stop is designed for 3-1/2" and 4" deep frames.

MANUAL STOPS MODEL NUMBER MBSR-192-25

M (roller or blade stop*)(left or right**)-
(roller type@)-(between frames)

*Specify RS for roller stop; BS for blade stop.

**Specify L for left hand; R for right hand.

@Specify 196 for 196S, 192 for 192S, 199 for 199S.

SPECIFICATIONS

ROLLER STOP: 1.9" dia. x 16 ga. steel 196S roller for medium duty; 2.5" dia. x 11 ga. steel 251S roller for heavy duty.

BEARINGS: Removable type, heavy duty ball bearing, with cast iron housings.

LOCK: Positive over center locking device to hold position.

BLADE STOP: 7 ga. formed angle.

WIDTHS: 24 hour shipments include 13", 15", 17", 19", 21", 23", 25", 27", 31", 33", 37", 39", 43", 45", 47" and 51" BF.



■ 24 hour shipment

PRODUCT STOPS

ANGLE AND ROLLER STOPS

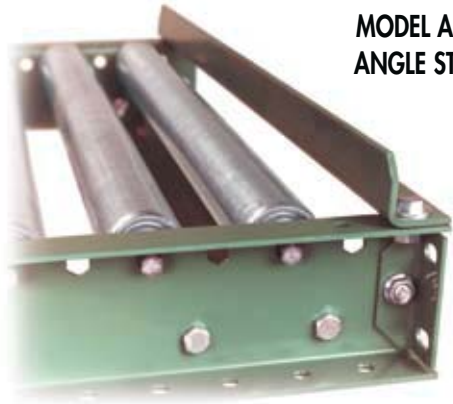

**MODEL ASM
ANGLE STOP**

Both angle and roller stops serve as an economical means to stopping goods at a given fixed point. "BR" brackets or angle stop quickly attaches to conveyor frame top flange.

ANGLE STOPS MODEL NUMBER ASM-33

AS (light, medium or heavy duty*)-(between frames**)
*Specify L for light duty, M for medium duty or H for heavy duty.

**Specify OAW for model ASL, available in 12", 18" and 24" OAW only and is suited specifically for wheel conveyors and 138 gravity series.

ROLLER STOPS MODEL NUMBER BR-196S-21

BR-(roller type*)-(between frames)

*Specify 138G, 196S, 196G, 192S, 199S, 254S, 251S or 297S.

SPECIFICATIONS

ANGLE STOP: Model ASL for light duty and ASM for medium duty applications (1-1/2" x 1-1/2" x 10 ga.); Model ASH for heavy duty applications (1-1/2" x 1-1/2" x 7 ga.).

ROLLER STOP: Includes pair of brackets and roller as specified in model number.

WIDTHS: Medium and heavy duty 24 hour shipments include 13", 15", 17", 19", 21", 23", 25", 27", 31", 33", 37", 39", 43", 45", 47" and 51" BF; light duty available in 12", 18" and 24" OAW.



**MODEL BR
ROLLER STOP**

■ 24 hour shipment

BUTT END STOPS



Butt end stops attach to end of conveyor frame into the butt couplings, providing a firm end-of-unit fixed stop. This stop is available in light, medium and heavy duty construction.

BUTT END STOPS MODEL NUMBER BSH-1.5-4-51

BS (light, medium, heavy or extra heavy duty*)-(height above frame)-(frame size)-(between frames@)
*Specify L for light duty, M for medium duty or H for heavy duty.

@Specify 12", 18" or 24" overall width for model BSL light duty butt end stop.

SPECIFICATIONS

CONSTRUCTION: 12 ga. for model BSL; 10 ga. for BSM; 7 ga. for BSH.

FRAME SIZE: Model BSL for 2.5" frame height ONLY; model BSM for 3.5", 4" and 4.5"; model BSH for 4" and 5" frame heights.

HEIGHT: Designed to extend 1.5" above top of frame.

WIDTHS: Model BSM and BSH widths include 13", 15", 17", 19", 21", 23", 25", 27", 31", 33", 37", 39", 43", 45", 47" and 51" BF; BSL available in 12", 18" and 24" OAW only.

■ 24 hour shipment



MISC. ACCESSORIES

PNEUMATIC BRAKE ASSEMBLY



Model PBA pneumatic brake assembly is used to automatically brake rollers for flow control and also for indexing when combined with pneumatic stop. Model above for medium duty applications while model at right designed for heavy duty use. Both shown mounted in optional conveyor.

PNEUMATIC BRAKES MODEL NUMBER PBAM-24

PBA(medium or heavy duty*)-(brake length)

*Specify M for medium duty or H for heavy duty

SPECIFICATIONS

AIR CYLINDERS: 1/2" stroke.

SOLENOID VALVE: Single, 110 volt.

CONSTRUCTION: 7 ga. formed with 5/16" pad.

LENGTH: 24", 36" and 48" (specify).

OPTIONAL: Double solenoid and electrical controls.

PBA
SINGLE AIR CYLINDER

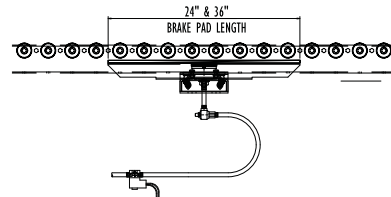

PBA
DOUBLE AIR CYLINDER

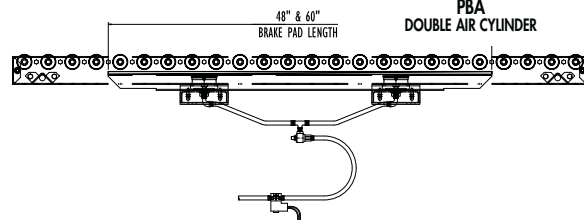

TRAFFIC COP



Traffic cops control merges allowing first carton striking an arm to pass. This action automatically locks the other arm in place until the first carton clears the arm. Model TC shown attached to optional conveyor.

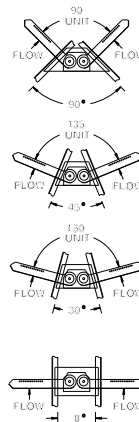

TRAFFIC COPS MODEL NUMBER TC-135-21-21

TC-(degree of unit*)-(left hand between frames)-
(right hand between frames)

*Specify 90°, 135°, 150° or 180°.

SPECIFICATIONS

CONSTRUCTION: Arms constructed of 10 ga. HRS steel with 14 ga. face, welded for unit durability.

UNIT ARC: 90°, 135°, 150° and 180° available.

TORQUE: Minimum 5" - lb.; maximum per arm 2500" - lb.

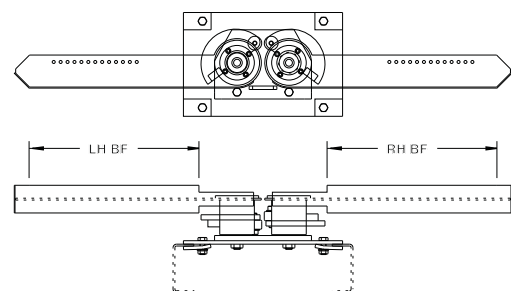

■ 3 week shipment



GATES MANUAL GATES



Manual gate assemblies are one of the most common conveyor accessories. Simple to install, manual gate assemblies offer passage to and from operator work cells as well as providing access for fork trucks, walkways, etc. Gates include hardware and conveyor section.

MANUAL GATES MODEL NO. (ROLLER) 196SGM-13-6-3

(gate model)-(between frames*)-(roller centers)-(length)
*Specify 12", 18" or 24" overall width on gate models
138GGM and 138AGM.

MANUAL GATES MODEL NO. (WHEEL) WSGM-18-12-2

(gate model)-(overall width*)-(wheels per foot)-(length)
*Specify 12", 18" or 24" overall width on gate models
WSGM and WAGM.

MODEL NO.	TYPE OF CONVEYOR	MINIMUM ELEVATION	MINIMUM LENGTH	MAXIMUM LENGTH	MAXIMUM WEIGHT
WSGM	GALV. WHEEL	3-5/8"	6"	5'	75 lbs.
WAGM	ALUM. WHEEL	3-5/8"	6"	5'	75 lbs.
138GGM	138G GALV.	3-3/8"	6"	5'	75 lbs.
138AGM	138A ALUM.	3-3/8"	6"	5'	75 lbs.
196SGM	196S STEEL	4-3/8"	6"	5'	75 lbs.
196GGM	196G GALV.	4-3/8"	6"	5'	75 lbs.
192SGM	192S STEEL	4-3/8"	6"	5'	75 lbs.
254SGM	254S STEEL	4-11/16"	6"	5'	75 lbs.

CAUTION: Maximum weight of gate section must NOT exceed 75 lbs. If gate weight (i.e. conveyor section) exceeds 75 lbs., use spring loaded gate below.

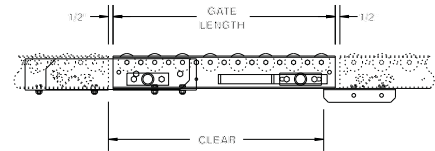

■ 24 hour shipment

SPRING LOADED GATES

MODEL NO.	TYPE OF CONVEYOR	MINIMUM ELEVATION	MINIMUM LENGTH	MAXIMUM LENGTH	MAXIMUM WEIGHT
WSGS	GALV. WHEEL	13" TOR	2'-6"	5'	150 lbs.
WAGS	ALUM. WHEEL	13" TOR	2'-6"	5'	150 lbs.
138GGS	138G GALV.	13" TOR	2'-6"	5'	150 lbs.
138AGS	138A ALUM.	13" TOR	2'-6"	5'	150 lbs.
196SGS	196S STEEL	13" TOR	2'-6"	5'	150 lbs.
196GGS	196G GALV.	13" TOR	2'-6"	5'	150 lbs.
192SGS	192S STEEL	13" TOR	2'-6"	5'	150 lbs.
254SGS	254S STEEL	13" TOR	2'-6"	5'	150 lbs.
251SGS	251S STEEL	13" TOR	2'-6"	5'	150 lbs.

CAUTION: If gate weight exceeds 150 lbs., consult factory.

SPRING LOADED GATES MODEL NO. (ROLLER) 251SGS-31*-6-2

(gate model)-(between frames*)-(roller centers)-(length)
*Specify 12", 18" or 24" overall width on gate models
138GGS and 138AGS.

SPRING LOADED GATES MODEL NO. (WHEEL) WAGS-24-20-3

(gate model)-(overall width*)-(wheels per foot)-(length)
*Specify 12", 18" or 24" overall width on gate models
WSGS and WAGS.

Spring loaded gate assemblies may be used to provide openings and walkways for operators, pedestrians or fork truck traffic or to simply make work areas in and around conveyors readily accessible. Tensioned springs offer increased lift capacity with minimal effort. Gates include hardware and conveyor section.

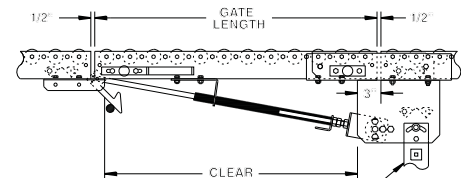

LOWER ELEVATION SUPPORT REQUIRED AT GATE HINGE SECTION. ADD 4-1/2" TO FRAME DEPTH TO DETERMINE PROPER SUPPORT.

■ 24 hour shipment



SUPPORT ACCESSORIES CASTERS

CASTER	CODE/CAPACITY PER PAIR	CASTER	CODE/CAPACITY PER PAIR
4" DIA. RUBBER RIGID	4RR/600 lbs.	4" DIA. RUBBER SWIVEL W/TOE BRAKE	4RSB/-
4" DIA. STEEL RIGID	4SR/700 lbs.	6" DIA. RUBBER RIGID	6RR/1120 lbs.
4" DIA. V-GROOVE RIGID	4VR/-	6" DIA. STEEL RIGID	6SR/1150 lbs.
4" DIA. RUBBER SWIVEL	4RS/600 lbs.	6" DIA. RUBBER SWIVEL	6RS/1120 lbs.
4" DIA. STEEL SWIVEL	4SS/700 lbs.	6" DIA. STEEL SWIVEL	6SS/1150 lbs.
4" DIA. V-GROOVE SWIVEL	4VS/-	6" DIA. STEEL SWIVEL W/BRAKE	6SSB/-
FLOORLOCK FOR 4" CASTER	-	FLOORLOCK FOR 6" CASTER	-

CASTERS FOR LIGHT DUTY CONVEYORS SLC-5-16-4RSBF

SLC-(elevation code)-(between frames*)-(caster model**)-(floorlock@)

*Specify 10", 16" or 22" between frames only. Model SLC is suited specifically for wheel conveyors and 138 gravity series.

**See chart for caster model number.

@Specify F if floorlock required.

CASTERS FOR MEDIUM DUTY CONVEYORS SMC-4-13-4RSBF

S (medium or heavy duty*) C-(elevation code)-(between frames)-(caster model**)-(floorlock@)

*Specify M for medium duty supports and H for heavy duty supports.

**See chart for caster model number.

@Specify F if floorlock required.

SPECIFICATIONS

CASTERS: 4" dia. or 6" dia., steel or rubber, swivel or rigid, V-groove casters; floor locks, wheel brakes available. Two casters supplied per support with enlarged mounting plate welded to legs.

CAPACITY: Up to 1150 lb. caster capacity. Consult factory for heavy duty casters.

OPTIONAL: Angle track for V-groove.



■ 24 hour shipment

■ 2 week shipment

KNEE BRACE AND ADJUSTABLE SUPPORT BRACKET

MEDIUM DUTY KNEE BRACE MODEL KB CODE NO.	HEAVY DUTY KNEE BRACE MODEL HKB CODE NO.	POLYTIER KNEE BRACE PKB CODE NO.	NOSE-OVER KNEE BRACE MODEL NOKB CODE NO.
2	2	-	6
4	4	4	-
6	6	6	-
8	8	8	-
10	10	10	-
12	12	-	-
-	14	-	-

SPECIFY KNEE BRACE MODEL NUMBER KB-6

(model number*)-(code number)

*Specify KB (medium duty for SL or SM supports), HKB (heavy duty for SH or SS supports), PKB (for polytier supports) or NOKB (for mounting on nose-over).

ADJUSTABLE SUPPORT BRACKET C-3

C-3
C-3

SPECIFICATIONS

KNEE BRACE: Available in 3 styles; Model KB (10 ga.) for SL and SM supports, Model HKB (7 ga.) for SH and SS supports and Model PKB (10 ga.) for polytier supports.

C-3 ADJUSTABLE SUPPORT BRACKET:

10 ga. construction on support Models SL and SM; 7 ga. on Model SH.



KB knee braces add strength to permanent supports and stability in portable applications. C-3 adjustable support bracket allows support to be attached easily to conveyor.



■ 24 hour shipment



SPECIALTY SUPPORTS

POLYTIER SUPPORTS

Polytier supports provide installation for two tiers of conveyor. Additional cross pipes are available for multi-tier (three or more tier) installation.

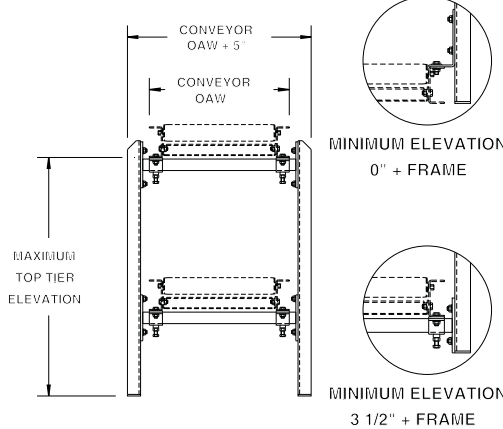

POLYTIER SUPPORTS MODEL NUMBER PSM-6-43

PS (light or medium duty*)-(elevation code)-(between frames**)
 *Specify L for light duty or M for medium duty.
 **Specify 12", 18" or 24" OAW for model PSL, available for 12", 18" and 24" OAW conveyors only and is suited specifically for wheel conveyors and 138 gravity series.

MINIMUM ELEVATION POLYTIER SUPPORTS PSM-6-0-43

PS (light or medium duty*)-(elevation code)-0-(between frames**)
 *Specify L for light duty or M for medium duty.
 **Specify 12", 18" or 24" OAW for model PSL, available for 12", 18" and 24" OAW conveyors only and is suited specifically for wheel conveyors and 138 gravity series.

SPECIFICATIONS

CONSTRUCTION: Upright legs 7 ga. channel construction; attachment "hat" brackets 7 ga.; cross pipes 1" inside dia.

CAPACITY: 1250 lbs. per cross member. Capacity per set of legs is 2500 lbs (including conveyor and product weight).

KNEE BRACES: One pair per set of legs.

ELEVATION CODE	MAX. TOP TIER ELEV.	ELEVATION CODE	MAX. TOP TIER ELEV.
1	20-1/2"	9	68-1/2"
2	26-1/2"	10	74-1/2"
3	32-1/2"	11	80-1/2"
4	38-1/2"	12	86-1/2"
5	44-1/2"	13	92-1/2"
6	50-1/2"	14	98-1/2"
7	56-1/2"	15	104-1/2"
8	62-1/2"		

WIDTHS: 24 hour shipments include 13", 15", 17", 19", 21", 23", 25", 27", 31", 33", 37", 39", 43", 45", 47" and 51" BF.

■ 24 hour shipment

CEILING HANGERS

When conveyors must be suspended from ceiling in overhead installation, Roach ceiling hanger assemblies provide a comfortable fit. Rods are all-threaded to allow for ease of vertical adjustment at ANY elevation.

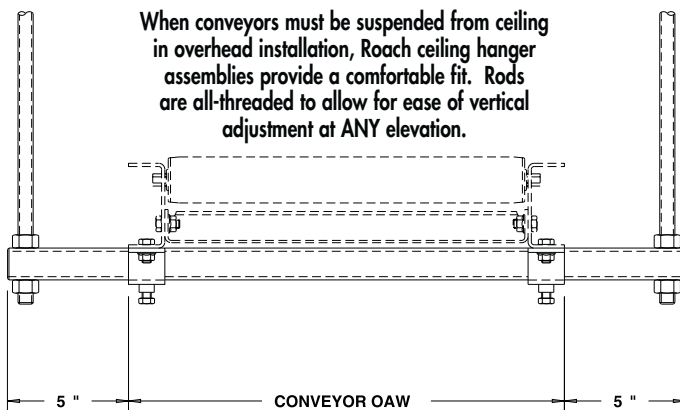

CEILING HANGERS MODEL NO. (LIGHT DUTY) CHL-18

CHL-(overall width*)
 *Specify 12", 18" or 24" overall width ONLY.

CEILING HANGERS MODEL NO. (MED. DUTY) CHM-21

CHM-(between frames)
 NOTE: If attaching to powered conveyor, specify model number for proper allocation of spacer channels, if required. Ceiling hangers for 24 hour shipment are designed for light & medium duty applications (14, 12 and 10 ga. frames). For heavy duty applications (not included in 24 hour shipments), consult factory for pricing & availability.

SPECIFICATIONS

HANGERS: (2) 7' long threaded rods (5/8" dia. - 11 UNC) provide nom. 6' product clearance.

MOUNTING BRACKETS: Cross-pipe to span underneath conveyor is painted 1" I.D. steel pipe; Retainer or "Hat" brackets bolt to lower flange of conveyor frame are 7 ga.

WIDTHS: 24 hour shipments include 13", 15", 17", 19", 21", 23", 25", 27", 31", 33", 37", 39", 43", 45", 47" and 51" BF.

■ 24 hour shipment



SUPPORTS

LIGHT DUTY TRIPOD SUPPORTS



TRIPOD
400 lbs. capacity

Tripod supports are the choice for fast set-up or temporary installations. Easily adjustable, tripods are designed for wheel conveyors and 138 gravity series roller conveyors. Tripods are simply placed underneath conveyor section crossbrace as shown in detail at right.

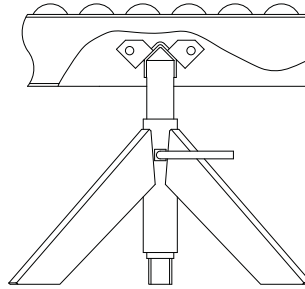

SPECIFY MODEL NUMBER FOR TRIPODS T-18-40

T-(overall width*)-(elevation code)

*Specify 12", 18" or 24" overall width only. Tripods are suited specifically for wheel conveyors and 138 gravity series conveyors ONLY.

SPECIFICATIONS

CONSTRUCTION: Top channel of tripod is 1-9/16" x 15/16" x 12 ga. welded to 1" inside diameter pipe. Tripod base is 12 ga. construction.

ELEVATION CODE	HEIGHT ADJUSTMENT MIN. (TOP OF TRIPOD)	HEIGHT ADJUSTMENT MAX. (TOP OF TRIPOD)	12" OAW WT. (lbs.)	18" OAW WT. (lbs.)	24" OAW WT. (lbs.)
18	9-1/4"	15-1/4"	8	9	10
30	15-1/4"	27-1/4"	11	12	13
40	21-1/4"	37-1/4"	13	14	15
52	27-1/4"	49-1/4"	15	16	17
72	37-1/4"	69-1/4"	18	19	20
110	57-1/4"	107-1/4"	25	26	27

■ 24 hour shipment

SINGLE LEG SUPPORTS

ELEVATION CODE	MODEL SLL/SLM HEIGHT ADJUSTMENT MIN. (TOP OF LEG)	MODEL SLL/SLM HEIGHT ADJUSTMENT MAX. (TOP OF LEG)	MODEL SLH HEIGHT ADJUSTMENT MIN. (TOP OF LEG)	MODEL SLH HEIGHT ADJUSTMENT MAX. (TOP OF LEG)
1	7-1/4"	10-1/4"	6-1/4"	7-3/4"
2	10-1/4"	13-1/4"	7-3/4"	10-3/4"
3	13-1/4"	16-1/4"	10-3/4"	13-3/4"
4	16-1/4"	22-1/4"	13-3/4"	16-3/4"
5	20-1/4"	26-1/4"	16-3/4"	19-3/4"
6	24-1/4"	36-1/4"	19-3/4"	25-3/4"
7	34-1/4"	46-1/4"	25-3/4"	31-3/4"
8	46-1/4"	58-1/4"	31-3/4"	43-3/4"
9	58-1/4"	70-1/4"	43-3/4"	55-3/4"
10	70-1/4"	82-1/4"	55-3/4"	67-3/4"
11	80-1/4"	92-1/4"	67-3/4"	79-3/4"
12	90-1/4"	104-1/4"	79-3/4"	91-3/4"

SINGLE LEG SUPPORTS MODEL NUMBER SLM-6

SL (light, medium or heavy duty)-(elevation code)



SPECIFICATIONS

CONSTRUCTION: SLL and SLM 12 ga. inside and outside channel assemblies with 10 ga. C-3 pivot plate. SLH 10 ga. inside and outside channel assemblies with 7 ga. C-3 pivot plate.

Single leg supports provide support where full "H-type" permanent supports are not normally required such as 90° curves with continuous side rails or where support cross-brace cannot be used.



■ 24 hour shipment

SUPPORTS

MODEL SL LIGHT DUTY PERMANENT SUPPORTS



MODEL SL
1500 lbs. support capacity

SPECIFICATIONS

CONSTRUCTION: 12 ga. inside and outside channel assemblies; C-3 plates are 10 ga.; cross braces are 10 ga. up to 27" BF and 7 ga. 31" BF and above.

WIDTHS: 24 HR shipments include SL in 10", 16" & 22" BF ONLY.

LIGHT DUTY SUPPORTS MODEL NUMBER SL-6-10

SL-(elevation code)-(between frames*)
*Specify 10", 16" or 22" between frames which is available for 12", 18" and 24" OAW conveyors ONLY and is suited specifically for wheel conveyors and 138 gravity series.

ELEVATION CODE	HEIGHT ADJUSTMENT MIN. (TOP OF SUPPORT)	HEIGHT ADJUSTMENT MAX. (TOP OF SUPPORT)	10"-22" BF WEIGHT (lbs.)
1	7-1/4"	10-1/4"	11
2	10-1/4"	13-1/4"	13
3	13-1/4"	16-1/4"	15
4	16-1/4"	22-1/4"	17
5	20-1/4"	26-1/4"	22
6	24-1/4"	36-1/4"	24
7	34-1/4"	46-1/4"	28
8	46-1/4"	58-1/4"	35
9	58-1/4"	70-1/4"	39
10	70-1/4"	82-1/4"	43
11	80-1/4"	92-1/4"	47
12	92-1/4"	104-1/4"	51

■ 24 hour shipment

MODEL SM MEDIUM DUTY PERMANENT SUPPORTS

ELEVATION CODE	HEIGHT ADJUSTMENT MIN. (TOP OF SUPPORT)	HEIGHT ADJUSTMENT MAX. (TOP OF SUPPORT)	7-21" BF WT. (lbs.)	22-27" BG WT. (lbs.)	28-39" BF WT. (lbs.)	40-51" BF WT. (lbs.)
1	7-1/4"	10-1/4"	10	11	15	17
2	10-1/4"	13-1/4"	12	13	16	18
3	13-1/4"	16-1/4"	14	15	18	20
4	16-1/4"	22-1/4"	16	17	20	22
5	20-1/4"	26-1/4"	21	23	30	33
6	24-1/4"	36-1/4"	23	25	32	36
7	34-1/4"	46-1/4"	27	29	36	39
8	46-1/4"	58-1/4"	34	36	47	53
9	58-1/4"	70-1/4"	38	40	52	57
10	70-1/4"	82-1/4"	42	44	56	61
11	80-1/4"	92-1/4"	46	48	60	65
12	92-1/4"	104-1/4"	50	52	64	69

MEDIUM DUTY SUPPORTS MODEL NO. SM-5-39

SM-(elevation code*)-(between frames)
*See chart at left

MINIMUM ELEVATION SUPPORTS MODEL NO. SM0-1-17

SM0-(elevation code*)-(between frames)
*See chart below.

SPECIFICATIONS

CONSTRUCTION: 12 ga. inside and outside channel assemblies; C-3 plates are 10 ga.; cross braces are 10 ga. up to 27" BF and 7 ga. 31" BF and above.

WIDTHS: 24 HR shipments include 7", 13", 15", 17", 19", 21", 23", 25", 27", 31", 33", 37", 39", 43", 45", 47" & 51" BF.

MIN. ELEVATION MEDIUM DUTY ELEVATION CODE	HEIGHT ADJ. RANGE (TOP OF SUPPORT)	UP TO 27" BF WT. (lbs.)	27"-51" BF WT. (lbs.)
1	3-1/2" — 4-1/8"	10	17
2	4-1/8" — 4-3/4"	10	17
3	4-3/4" — 5-3/8"	10	17
4	5-3/8" — 6"	10	17
5	6" — 6-5/8"	10	17
6	6-5/8" — 7-1/4"	10	17



MODEL SM
1500 lbs. support capacity

■ 24 hour shipment ■ 2 week shipment



SUPPORTS

MODEL SH HEAVY DUTY PERMANENT SUPPORTS

ELV. CODE	HEIGHT ADJ. MIN. (TOP OF SUPPORT)	HEIGHT ADJ. MAX. (TOP OF SUPPORT)	7-21" BF WT. (lbs.)	22-27" BF WT. (lbs.)	28-39" BF WT. (lbs.)	40-51" BF WT. (lbs.)
1	6-1/4"	7-3/4"	12	13	17	18
2	7-3/4"	10-3/4"	13	14	18	19
3	10-3/4"	13-3/4"	14	15	19	20
4	13-3/4"	16-3/4"	17	18	21	23
5	16-3/4"	19-3/4"	18	19	22	24
6	19-3/4"	25-3/4"	22	24	31	35
7	25-3/4"	21-3/4"	27	29	37	40
8	31-3/4"	43-3/4"	31	33	40	44
9	43-3/4"	55-3/4"	40	42	53	59
10	55-3/4"	67-3/4"	45	47	58	64
11	67-3/4"	79-3/4"	50	52	64	69
12	79-3/4"	91-3/4"	57	59	70	75

HEAVY DUTY SUPPORTS MODEL NO. SH-4-51

SH-(elevation code*)-(between frames)
*See chart at left.



MODEL SH
3000 lbs. support capacity

SPECIFICATIONS

CONSTRUCTION: 10 ga. inside and outside channel assemblies; C-3 plates are 7 ga.; cross braces are 10 ga. up to 27" BF and 7 ga. 31" BF and above.

WIDTHS: 24 hour shipment includes 7", 9", 13", 15", 17", 19", 21", 23", 25", 27", 31", 33", 37", 39", 43", 45", 47", 51" BF only; 54", 57" and 63" BF available in models SH-1 to SH-6.

MODEL SHO HEAVY DUTY

ELEVATION CODE	HEIGHT ADJ. RANGE (TOP OF SUPPORT)	UP TO 27" BF WT. (lbs.)	28"-51" BF WT. (lbs.)
1	3-1/2" — 4-1/8"	13	18
2	4-1/8" — 4-3/4"	13	18
3	4-3/4" — 5-3/8"	13	18
4	5-3/8" — 6"	13	18
5	6" — 6-5/8"	13	18

MINIMUM ELEVATION SUPPORTS MODEL NO. SH0-5-33

SH0-(elevation code*)-(between frames)
*See chart below left.

HEAVY DUTY STRUCTURAL SUPPORTS

■ 24 hour shipment



MODEL SS
6000 lbs. support capacity

STRUCTURAL SUPPORTS MODEL NUMBER SS-4-31

SS-(elevation code)-(between frames)

3530 STRUCTURAL SUPPORTS MODEL NO. SS3530-6-45

SS3530-(elevation code)-(between frames)



MODEL SS3530
12000 lbs. support capacity

MODEL SS ELEV. CODE	HT. ADJ. RANGE (TOP OF SUPPORT)	7"-23" BF WT. (lbs.)	24"-51" BF WT. (lbs.)	52"-63" BF WT. (lbs.)	MODEL SS ELEV. CODE	HT. ADJ. RANGE (TOP OF SUPPORT)	7"-23" BF WT. (lbs.)	24"-51" BF WT. (lbs.)	52"-63" BF WT. (lbs.)	MODEL SS3530* ELEV. CODE	HT. ADJ. RANGE (TOP OF SUPPORT)
1	7-1/4" — 10-1/4"	26	39	44	13	99-1/2" — 114-1/2"	154	191	207	1	8-3/8" — 10-5/8"
2	10-1/4" — 13-1/4"	31	44	50	14	102-1/2" — 117-1/2"	160	198	214	2	10-3/8" — 13-1/8"
3	13-1/4" — 16-1/4"	35	47	53	15	105-1/2" — 120-1/2"	163	201	217	3	12-7/8" — 18-1/8"
4	16-1/4" — 22-1/4"	40	53	59	16	108-1/2" — 126-1/2"	166	204	220	4	17-7/8" — 23-3/8"
5	20-1/4" — 26-1/4"	45	58	64	17	112-1/2" — 130-1/2"	170	208	224	5	23-1/8" — 28-5/8"
6	24-1/4" — 36-1/4"	56	69	75	18	116-1/2" — 140-1/2"	180	218	234	6	28-3/8" — 33-7/8"
7	34-1/4" — 46-1/4"	83	108	119	19	126-1/2" — 150-1/2"	189	227	243	7	33-5/8" — 39-1/8"
8	46-1/4" — 58-1/4"	92	117	128	20	138-1/2" — 162-1/2"	200	238	254	8	38-7/8" — 44-3/8"
9	58-1/4" — 70-1/4"	105	130	141	21	150-1/2" — 174-1/2"	211	249	265	-	-
10	70-1/4" — 82-1/4"	116	141	152	22	162-1/2" — 186-1/2"	222	260	276	-	-
11	80-1/4" — 92-1/4"	136	174	191	23	172-1/2" — 196-1/2"	231	269	285	-	-
12	92-1/4" — 104-1/4"	147	185	202	24	184-1/2" — 208-1/2"	241	279	295	-	-

SPECIFICATIONS

BF'S: 24 hr. ship includes 7", 9", 11", 13", 15", 17", 19", 21", 23", 25", 27", 31", 33", 35", 37", 39", 43", 45", 47", 51" BF only; 54", 57" & 63" BF 2 wk. ship.



*Model SS3530 adjustable in 1/4" increments ONLY.

■ 24 hour shipment ■ 2 week shipment

GUARD RAILS GUARD RAILS

MODEL GC

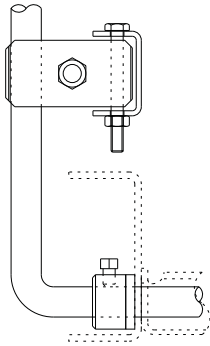

MODEL GA1.5
MODEL HGA1.5

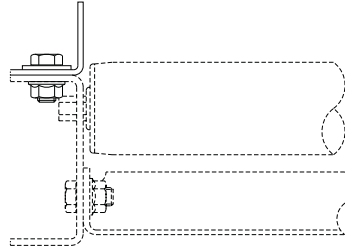

ALWAYS SPECIFY CONVEYOR MODEL NUMBER AND FLANGE WIDTH GUARD RAILS WILL MOUNT ON

MODEL FSG

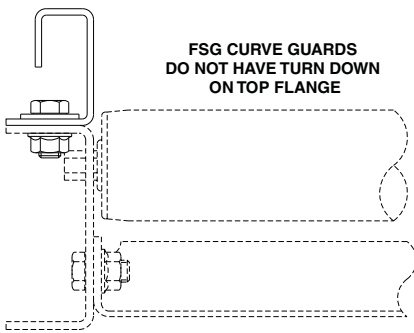

MODEL FC

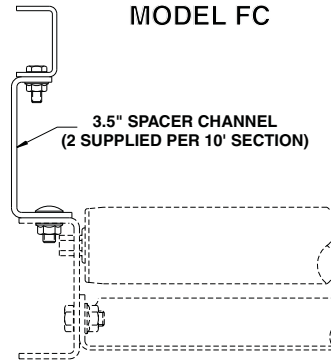

SPECIFICATIONS

CONSTRUCTION: All medium duty rails are 12 ga. HRS steel; heavy duty rails are 7 ga. HRS steel; all are powder painted EXCEPT guard rails for light duty conveyors normally supplied with galv. or alum. frames which are galv.; with mounting holes.

GUARD RAILS: Available in several styles; model GC, adjustable channel guards; model FC, fixed channel guards; model GA1.5, angle guards (1.5" high); model HGA1.5, heavy duty angle guards (1.5" high); model FSG, formed steel guards (7 heights from 2" to 24" high). Specify both sides or outside only when ordering AND conveyor model number to ensure receipt of proper guard rails & mounting hardware which is supplied as required.

GUARD RAIL MODEL NO.	WT./FT. (lbs.) BOTH SIDES
GC	3.9
FC	3.5
GA1.5	2.3
FSG-2	4.2
FSG-4	5.7
FSG-6	7.2
HGA1.5	4.0

MODEL GC GUARD RAILS MODEL NO. GC-90-15

GC-(degree or length)-(between frames)

GA1.5 GUARD RAILS MODEL NO. (STRAIGHT) GA-1.5-C-60

(model*)-(guard height)-(bottom flange code**)-(length)
*Specify GA or HGA for heavy duty guard rails.
**Specify A (.75"), B (1") or C (1.5").

GA1.5 GUARD RAILS MODEL NO. (CURVE) GGA1.51.59032.513

(GGA1.5 or PGA1.5*) (bottom flange**) (degree#)
(radius##) (assembly code@)

*Specify GGA1.5 for galv.-to be used only on models supplied w/ galv. or alum. frames; PGA1.5 for painted.

**Specify .75", 1" or 1.5".

##Specify 30°, 45°, 60° or 90°.

##Specify applicable inside radius or outside radius.

@Specify N for inside guard only, U for outside guard only or between frames width for guards on both sides.

FSG GUARD RAILS MODEL NO. (STRAIGHT) FSG-4-C-36

FSG-(guard height*)-(bottom flange code**)-(length)

*Specify 2, 4 or 6.

**Specify A (.75") or C (1.5").

FSG GUARD RAILS MODEL NO. (CURVE) GFSG2-1.59032.5U

(model*) (guard height**) (bottom flange#) (degree##)
(radius@) (assembly code@@)

*Specify GFSG for galv.-to be used only on models supplied w/ galv. or alum. frames; or PFSG for painted.

**Specify 2, 4, 6, 8, 12, 18 or 24

#Specify .75", 1" or 1.5".

##Specify 30°, 45°, 60° or 90°.

@Specify applicable inside radius or outside radius.

@@Specify N for inside guard only, U for outside guard only or between frames width for guards on both sides.

MODEL FC GUARD RAILS MODEL NO. FC-60-39

FC-(degree or length)-(between frames)



■ 24 hour shipment

ROLLERS

ROLLERS FOR GRAVITY AND POWER APPLICATIONS

ROLLER #	OUTSIDE DIA.	WALL	MATERIAL	SHAFT DIA.	SHAFT RETENTION	BEARING #	BEARING MT.	MAX. LOAD	GRAVITY MODEL.	POWER/ MAX. SPEED
108G	1"	18 GA.	Galvanized	1/4" Round	Springloaded	BRW04710	Press In	35 lbs.	YES	-
138G	1-3/8"	18 GA.	Galvanized	1/4" Round	Springloaded	BRW04515	Swaged	50 lbs.	YES	-
138A	1-3/8"	18 GA.	Aluminum	1/4" Round	Springloaded	BRW04515-01	Swaged	35 lbs.	YES	-
138G	1-3/8"	18 GA.	Galvanized	5/16" Hex	Springloaded	BRW04520-01	Swaged	50 lbs.	-	120FPM
138A	1-3/8"	18 GA.	Aluminum	5/16" Hex	Springloaded	BRW04520	Swaged	35 lbs.	-	120FPM
138T	1.9" — 1-3/8"	16 GA.	Steel	5/16" Hex	Springloaded	BRW04531-02/04519	Press In/ Swaged	100 lbs.	YES	120FPM
196A	1.9"	.200	Aluminum	7/16" Hex	Springloaded	BRW04530	Swaged	50 lbs.	YES	-
196G	1.9"	16 GA.	Galvanized	7/16" Hex	Springloaded	BRW04530	Swaged	260 lbs.	YES	120FPM
196S	1.9"	16 GA.	Steel	7/16" Hex	Springloaded	BRW04530	Swaged	260 lbs.	YES	120FPM
192S	1.9"	12 GA.	Steel	7/16" Hex	Springloaded	BRW04535	Swaged	260 lbs.	YES	120FPM
192S	1.9"	12 GA.	Steel	7/16" Hex	Springloaded	BRW04586	Press In	300 lbs.	-	150FPM
199S	1.9"	9 GA.	Steel	7/16" Hex	Springloaded	BRW04535	Swaged	260 lbs.	YES	150FPM
254S	2.5"	14 GA.	Steel	7/16" Hex	Springloaded	BRW04581	Press In	290 lbs.	YES	150FPM
254T	2.5" — 1-11/16"	14 GA.	Steel	7/16" Hex	Springloaded	BRW04581	Press In	290 lbs.	YES	120FPM
251S	2.5"	11 GA.	Steel	11/16" Hex	Springloaded	BRW04564	Crimped	540 lbs.	YES	-
251S	2.5"	11 GA.	Steel	11/16" Hex	Springloaded	BRW04565	Crimped	540 lbs.	-	150FPM
297S	2-9/16"	7 GA.	Steel	11/16" Hex	Springloaded	BRW04564	Crimped	540 lbs.	YES	-
297S	2-9/16"	7 GA.	Steel	11/16" Hex	Springloaded	BRW04565	Crimped	540 lbs.	-	150FPM
3509S	3.5"	9 GA.	Steel	11/16" Hex	Springloaded	BRW04578	Crimped	700 lbs.	YES	-
3530S	3.5"	.300	Steel	1-1/16" Hex	Pinned	BRW04737	Press In	2500 lbs.	YES	-

*ALL LOADS ARE RATED AT 60 SFM (SURFACE FEET PER MINUTE) AND ARE BASED ON MINIMUM STANDARD BF WIDTH. **For higher speeds, consult factory.

LIGHT DUTY ROLLERS

MODEL 108G w/ BRW04710



MODEL 138G w/ BRW04515
MODEL 138A w/ BRW04515-01



MODEL 138G w/ BRW04520-01
MODEL 138A w/ BRW04520

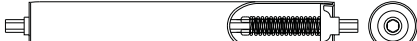

MODEL 138T w/ BRW04531-02
AND BRW04519 (SMALL END)

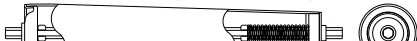

MEDIUM DUTY ROLLERS

MODEL 254T w/ BRW04575



MEDIUM DUTY ROLLERS

MODEL 196S w/ BRW04530
MODEL 196G w/ BRW04530
MODEL 196A w/ BRW04530



MODEL 192S w/ BRW04535



MODEL 192S w/ BRW04586



MODEL 199S w/ BRW04535



MODEL 254S w/ BRW04575



HEAVY DUTY ROLLERS

MODEL 251S w/ BRW04564
MODEL 251S w/ BRW04565



MODEL 297S w/ BRW04565
MODEL 297S w/ BRW04564



MODEL 3509S w/ BRW04578

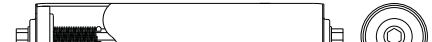

MODEL 3530S w/ BRW04737



ROLLER MODEL	BEARING MODEL	7" BF WT. (lbs.)	9" BF WT. (lbs.)	11" BF WT. (lbs.)	13" BF WT. (lbs.)	15" BF WT. (lbs.)	17" BF WT. (lbs.)	19" BF WT. (lbs.)	21" BF WT. (lbs.)	23" BF WT. (lbs.)	25" BF WT. (lbs.)	27" BF WT. (lbs.)	31" BF WT. (lbs.)	33" BF WT. (lbs.)	35" BF WT. (lbs.)	37" BF WT. (lbs.)	39" BF WT. (lbs.)	43" BF WT. (lbs.)	45" BF WT. (lbs.)	47" BF WT. (lbs.)	51" BF WT. (lbs.)
196S	BRW04530	1.6	1.9	2.2	2.5	2.7	2.9	3.3	3.6	3.8	4.1	4.4	4.9	5.2	5.5	5.8	6.1	6.7	7.0	7.3	7.8
196G	BRW04530	1.6	1.9	2.3	2.6	2.8	3.0	3.4	3.7	3.9	4.3	4.6	5.1	5.4	5.7	6.0	6.3	7.0	7.3	7.6	8.1
192S	BRW04535	2.3	2.8	3.4	3.8	4.5	5.2	5.6	6.0	6.6	7.2	7.7	8.8	9.4	9.9	10.6	11.0	12.1	12.7	13.2	14.3
199S	BRW04586	2.6	3.3	4.0	4.5	5.3	6.1	6.6	7.1	7.8	8.5	9.2	10.5	11.2	11.8	12.6	13.1	14.5	15.2	15.8	17.1
254S	BRW04581	2.1	2.5	3.0	3.4	3.9	4.4	4.8	5.2	5.7	6.2	6.6	7.5	8.4	9.3	9.8	10.2	11.3	11.8	12.3	13.3
254T	BRW04581	2.0	2.4	2.8	3.2	3.7	4.1	4.5	4.9	5.4	5.8	6.2	7.0	7.5	7.9	8.3	8.7	9.6	10.0	10.4	11.3
251S	BRW04564	4.2	4.9	5.6	6.4	7.1	7.8	8.5	9.2	9.9	10.7	11.4	12.8	13.5	14.3	15.0	15.7	17.1	17.9	18.6	20.0
297S	BRW04565	4.6	5.6	6.7	7.6	8.7	9.8	10.8	11.8	12.3	13.8	15.3	16.9	17.9	19.0	20.0	21.0	23.0	24.1	25.1	27.2
3509S	BRW04560	6.5	7.7	8.8	9.9	11.0	12.1	13.3	14.4	15.6	16.7	17.8	20.1	21.2	22.3	23.5	24.6	26.9	28.0	29.1	31.4
3530S	BRW04735	11.2	13.5	15.9	18.3	20.6	23.0	25.3	27.6	30.0	32.3	34.7	39.4	41.8	44.1	46.4	48.8	53.5	55.9	58.2	62.8

ROLLER MODEL	BEARING MODEL	10" BF WTS. (lbs.)	16" BF WTS. (lbs.)	22" BF WTS. (lbs.)
138G	BRW04515	1.0	1.5	2.0
138A	BRW4515-01	0.9	1.3	1.8



■ 24 hour shipment ■ 2 week shipment